

Article number: 20251M1040AK

Description: E+G Setting bolt GN 251-M10-40-AK  
with nut

## Measures

Type AK



Type BK

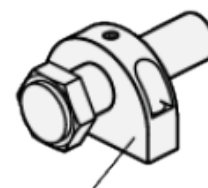
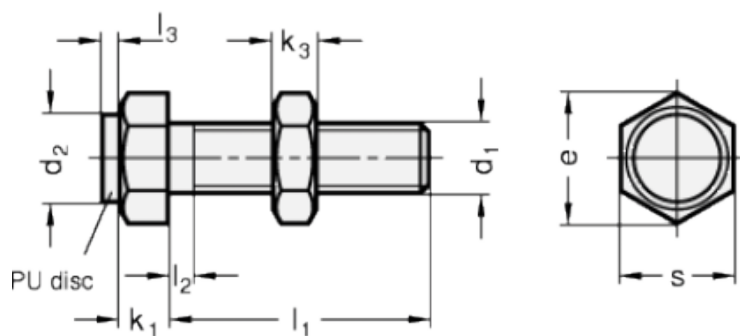

Mounting block GN 412.1

d	= M10	s = 17
e	= 19.6	
K	= -	
k1	= 7	
k2	= 8	
l1	= 40	
l2 max.	= 4.5	
l3	= -	